

4 5/8" OUTSWING OPERATOR/SIDELITE
VERTICAL MULLION

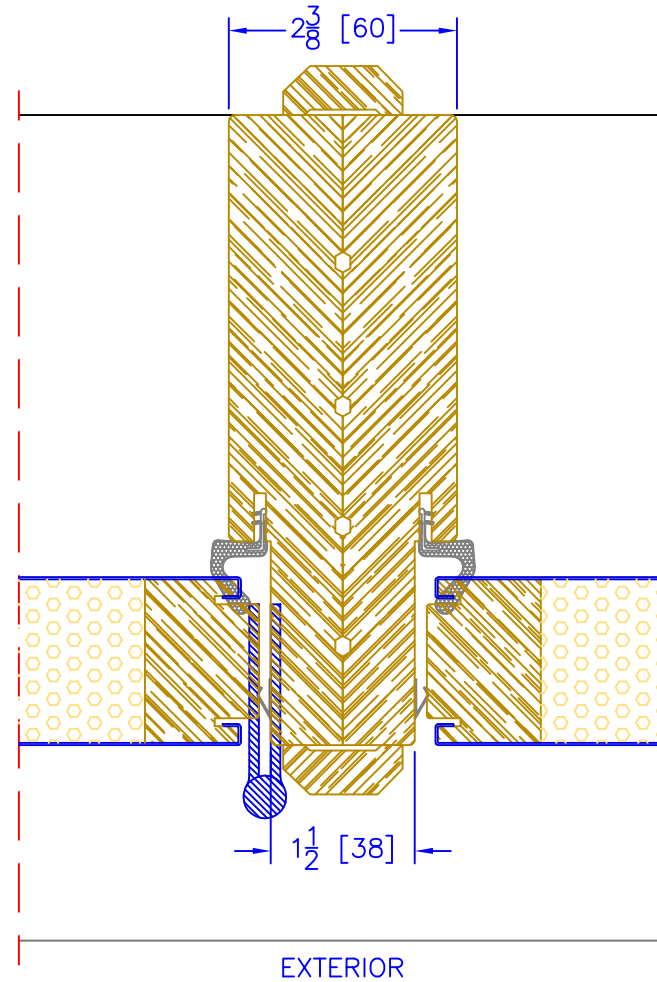

6 5/8" OUTSWING OPERATOR/SIDELITE
VERTICAL MULLION